

## END USER LICENSE AGREEMENT

---

**IMPORTANT - CAREFULLY READ THE FOLLOWING TERMS AND CONDITIONS OF THIS AGREEMENT.** This End User License Agreement ("Agreement") is a legal agreement between you, the user of Philips' portable computing device ("Product"), and Philips Mobile Computing Group ("Philips"), the manufacturer of the Product. The Product came with certain software products, and associated documentation, which are installed on the Product and/or included in the original Product packaging on external media. (All such software and documentation are collectively referred to as "Software".) **BY INSTALLING, COPYING, OR OTHERWISE USING THE SOFTWARE YOU ARE AGREEING TO BE BOUND BY THE TERMS OF THIS AGREEMENT. IF YOU DO NOT AGREE TO THE TERMS OF THIS AGREEMENT, PHILIPS IS UNWILLING TO LICENSE THE USE OF THE SOFTWARE TO YOU. IN SUCH EVENT, YOU MUST NOT OPEN THE SEALED PRODUCT OR SOFTWARE AND MUST PROMPTLY RETURN THE SEALED PRODUCT AND SOFTWARE TO THE PLACE YOU OBTAINED IT FOR A FULL REFUND.**

---

- 1. Grant of License.** Philips hereby grants you the non-exclusive right to use the Software only as installed on the Product or, for Software which is not already installed on the Product, to install and use the Software on a single Product.
- 2. Ownership of the Software and Documentation.** You do not receive title or ownership to the Software, but merely the limited right to use the Software as specified in this Agreement.
- 3. Restrictions.** You may not: (i) copy the Software except for one copy for back-up, archival purposes provided that the copy contains all of the original Software's proprietary notices and is subject to all of the terms of this Agreement; (ii) modify, translate, reverse engineer, decompile, disassemble (except to the extent that this restriction is expressly prohibited by law) the Software or create derivative works based upon the Software; (iii) rent, lease, lend, or sublicense the Software; (iv) or transfer the Software except together with the sale or transfer of the Product and then only if you keep no copy of the Software, if you transfer all of the Software (including backup copies), and if the recipient agrees to comply with, and be bound by, the terms of this Agreement.
- 4. Termination.** This Agreement, and the licenses granted in it, is effective until terminated. This Agreement will terminate: (i) automatically if you fail to comply with the terms of this Agreement; or (ii) without prejudice to any other rights, upon written notice sent to you by Philips if Philips, in its sole judgment, believes that the Software is being used for a purpose not approved by it or that its rights are being jeopardized. In such event, you must destroy all copies of the Software and all of its component parts immediately upon receipt of such notice.
- 5. Limited Warranty**
  - a.** For a period of one (1) year from the date of purchase by you, Philips warrants that the Product, excluding Software, shall function in substantial conformance with the performance requirements set forth in the end-user documentation under normal use and shall be free from defects in materials and/or workmanship.
  - b.** For a period of ninety (90) days from the date of purchase by you, Philips warrants:
    - (i) that the Software in object code in the Product ROM (or on the removable storage device ("Miniature Card") to be inserted in the miniature card socket of the Product, if applicable) shall function in substantial conformance with the performance requirements set forth in the end-user documentation under normal use; and (ii) that the media on which such Software is furnished shall be free from defects in materials and/or workmanship.

- c. For a period of thirty (30) days from the date of purchase by you, Philips warrants:
    - (i) that the Software in object code form on all external media shall function in substantial conformance with the performance requirements set forth in the end-user documentation under normal use; (ii) and that the media on which such Software is furnished shall be free from defects in materials and/or workmanship.
  - d. This Limited Warranty does not apply to the finish or cosmetic appearance of the Product.
  - e. This Limited Warranty is provided only to you, the original purchaser of the Product. It is not transferable by you to any other person or entity.
  - f. This Limited Warranty is void if failure has resulted from accident, abuse, or misapplication. Without limiting the foregoing, battery leakage, bending of the unit, a broken LCD display or any cracks in the LCD display will be presumed to have resulted from misuse or abuse.
  - g. Your sole and exclusive remedy in the event of a breach of warranty shall be, at Philips' option, the replacement of the Product or the Software with a remanufactured or refurbished Product or refund of the price you paid, provided you return the Product to Philips together with a copy of your receipt.
- 6. Warranty Disclaimer / Limitation of Liability.**
- a. **EXCEPT AS SPECIFICALLY SET FORTH ABOVE, PHILIPS DISCLAIMS ALL WARRANTIES, INCLUDING WITHOUT LIMITATION, THE IMPLIED WARRANTIES OF MERCHANTABILITY AND FITNESS FOR A PARTICULAR PURPOSE.**
  - b. **PHILIPS SHALL NOT BE LIABLE FOR ANY LOSS OF USE, DAMAGES RESULTING FROM MATHEMATICAL INACCURACY, LOSS OF STORED DATA, OR INDIRECT OR CONSEQUENTIAL DAMAGES ARISING OUT OF THE USE OR INABILITY TO USE THE PRODUCT OR ANY SOFTWARE EVEN IF PHILIPS HAS BEEN ADVISED OF THE POSSIBILITY OF SUCH DAMAGES. IN NO EVENT SHALL PHILIPS' LIABILITY EXCEED THE COST OF THE PRODUCT, WHETHER YOUR CLAIM IS BASED ON CONTRACT, TORT, WARRANTY, OR ANY OTHER LEGAL THEORY. SOME STATES OR JURISDICTIONS DO NOT ALLOW THE EXCLUSION OR LIMITATION OF IMPLIED WARRANTIES OR LIMITATION OF IMPLIED WARRANTIES OR LIABILITY FOR INCIDENTAL OR CONSEQUENTIAL DAMAGES, SO THE ABOVE LIMITATIONS MAY NOT APPLY TO YOU.**
- 7. Microsoft Software.** This Agreement does not apply to Microsoft software. Your rights to use, and restrictions on, Microsoft software are governed by a separate end user license agreement which applies exclusively to Microsoft software.
- 8. U.S. Government Restricted Rights.** Pursuant to DFARS 227.7202 and FAR 12.212, the Software is subject to, and restricted by, this Agreement. Use, duplication, or disclosure by the United States Government is governed solely by the terms and conditions contained herein.
- 9. Choice of Law.** This Agreement is governed and construed under the laws of the State of California, except those portions pertaining to conflicts of law. You consent to the exclusive jurisdiction of the state and federal courts sitting in the State of California.
- 10. Entire Agreement.** This Agreement constitutes the entire agreement with you concerning the Software. It may not be amended or altered except in a written document signed by you and an authorized representative of Philips.

# **VELO 1**

## **Philips Velo™ 1 with Microsoft Windows CE 2.0 User's Guide**

**includes instructions for upgrading to  
Microsoft Windows CE 2.0**

©1998 Philips Electronics North America Corporation. All rights reserved.

Information in this document is subject to change without notice. No part of this document may be reproduced or transmitted in any form or by any means, electronic or mechanical, for any purpose, without the express written permission of Philips Mobile Computing Group, a division of Philips Electronics North America ("Philips").

Philips or its affiliated companies, may have patents, patent applications, trademarks, copyrights, or other intellectual property rights covering the subject matter in this document. Except as expressly provided in any written license agreement from Philips, the furnishing of this document does not give you any license to patents, trademarks, copyrights, or other intellectual property of Philips or its affiliated companies.

Velo and the Velo logo are either registered trademarks or trademarks of Philips in the United States and/or other countries.

Microsoft, MS-DOS, MS, Windows, Windows NT, Win32, ActiveSync, Outlook, Pocket Outlook, Pocket PowerPoint, Windows CE, and the Windows logo are either trademarks or registered trademarks of Microsoft Corporation in the USA and/or other countries.

Other products and company names mentioned herein may be the trademarks of their respective owners.

<b>Introduction</b>	<b>6</b>
<b>Step 1: Set Up Your Velo 1 for the Upgrade</b>	<b>8</b>
<b>Step 2: Install Windows CE Services 2.0 on Your Desktop Computer</b>	<b>15</b>
<b>Step 3: Prepare Your Velo 1 and Your Desktop Computer for Velo 1 Application Installation</b>	<b>17</b>
<b>Step 4: Install Velo Applications From the <i>Velo 1 Upgrade</i> CD</b>	<b>20</b>
<b>Step 5: Retrieve Your Data</b>	<b>23</b>
<b>Using Your Velo 1</b>	<b>25</b>
What's on your Velo 1?	25
Windows CE 2.0	26
Other software	28
Tips for using your Velo 1	30
Battery tips	32
Resetting your Velo 1	34
Frequently asked questions	35
Quick Start keys	37
Cleaning and Maintaining Your Velo 1	37
Using the built-in modem	38
<b>Hardware Specifications</b>	<b>39</b>
<b>Regulatory Information</b>	<b>42</b>

## Introduction

The Philips Velo™ 1 is a handheld PC (H/PC), a kind of computer that you can carry with you and use almost anywhere. It allows you to keep track of your appointments, take files with you, send and receive e-mail, connect to the World Wide Web, and much more.

Your package includes the following compact discs:

- ▶ **The Microsoft® Windows® CE compact disc.** This CD contains Windows CE® Services 2.0 with ActiveSync™ software for your desktop computer. With Windows CE Services, you can browse the contents of your Velo 1 from your desktop computer using My Computer or Windows Explorer. ActiveSync enables you to synchronize files and e-mail messages, as well as PIM data, and offers continuous background synchronization. The Windows CE Services compact disc also includes optional system extensions for Windows 95 or Windows NT® and optional Microsoft programs for your Velo 1.
- ▶ **The Philips Velo 1 Upgrade compact disc.** This disc includes programs and components of the Velo 1 applications and operating system.

**Important:** You'll need to install the software on both of these CDs. Instructions for installing the software on these discs are provided in this booklet.

This booklet is designed to get you up and running with your Velo 1 as quickly as possible. It also provides a brief overview of the operating system features and programs.

For additional help with installation, contact Philips technical support at 1-888-275-8356, or visit Philips on the World Wide Web at: [www.mobile.philips.com](http://www.mobile.philips.com).

For help with using your Velo 1, see the specific topics in Windows CE Services online Help and the Velo 1 online Help. For a more detailed description of the operating system, download the Microsoft Windows CE Guided Tour from Microsoft's Web site ([www.microsoft.com/WindowsCE](http://www.microsoft.com/WindowsCE)).

## Installing the Windows CE upgrade requires these steps:

- 1 Set up your Velo 1 for the upgrade.  
**If you purchased the Microsoft Windows CE 2.0 Upgrade Kit**, follow the steps on page 8.  
**If you purchased the Velo 1 with 12 MB of DRAM and the Microsoft Windows CE Upgrade Card already installed**, follow the steps on page 13.
- 2 Install Windows CE Services 2.0 (from the *Microsoft Windows CECD*) on your desktop computer.
- 3 Prepare your Velo 1 and your desktop computer for installing Velo 1 applications.
- 4 Install Velo 1 applications (from the *Velo 1 Upgrade CD*) onto your Velo 1.
- 5 Retrieve your Velo 1 data (only if you purchased the Upgrade Kit and saved your data in Step 1).

## Step 1: Set Up Your Velo 1 for the Upgrade

**Important:** If you purchased the Velo 1 with 12 MB of DRAM and the Microsoft Windows CE 2.0 Upgrade Card already installed, go to page 13.

If you purchased the Microsoft Windows CE 2.0 Upgrade Kit, you will complete these steps:

- Save your Velo 1 data
- Remove all the batteries from your Velo 1.
- Install the Windows CE 2.0 ROM Miniature Card.
- Install more RAM in your Velo 1.
- Reinsert all the batteries.

### 1a: Save your Velo 1 data.

Before you install the Windows CE 2.0 ROM Miniature Card, you must back up all data on your Velo 1. When you install the ROM Miniature Card, all programs, settings, files, and PIM data (Calendar, Contacts, and Tasks information) on your Velo 1 will be erased. **Many of these items cannot be restored from a backup file unless you follow the procedures below**, which explain how to back up all information on your Velo 1 to ensure that no data is lost. After you have installed the upgrades on both your Velo 1 and desktop computer, you will restore your data as described in “Step 5: Retrieve Your Data.”

**Programs** — After you complete the upgrade, you will need to reinstall any programs you've added to your Velo 1 from the original source. In some cases, existing programs may not be compatible with Windows CE 2.0. Check with the program's manufacturer to find out if you need a new version.

**Settings** — Program and device settings will be lost during the upgrade. Before you upgrade, write down any important settings, such as TCP/IP and network settings for remote connections, settings for Inbox services, alarms and reminders, desktop patterns, and sound schemes.



**Files** — Documents and data files can be backed up using H/PC Explorer; however, because Windows CE 2.0 and its components require more storage memory than the original version, you may not have enough memory to complete the upgrade. **To ensure that no data is lost, you should back up or copy individual files, including data on a flash miniature card, if you have one, onto your desktop computer.**

#### To back up individual files

- 1 On your desktop computer, create a new folder in which to save the backed-up files.
- 2 Connect your Velo 1 to your desktop computer, and start H/PC Explorer.
- 3 In H/PC Explorer, select the files and folders you want to back up, and drag them to the folder you created, or use the **Cut** and **Paste** commands to move the files from your Velo 1 to the backup folder.

**PIM data** — PIM data can be preserved by synchronizing your Velo 1 with Microsoft Schedule+ or Microsoft Outlook™ on your desktop computer immediately before upgrading.

#### To synchronize PIM data

- 1 Connect your Velo 1 to your desktop computer and start H/PC Explorer.  
If you have set H/PC Explorer to synchronize on connecting, synchronization will take place automatically.
- 2 If you have not set H/PC Explorer to synchronize on connecting, in H/PC Explorer on your desktop computer, click **Synchronize Now** on the **Tools** menu.

**Mail messages** — If you have Microsoft Exchange or Outlook on your desktop computer, transfer important messages to the Inbox on your desktop computer, using the Inbox Transfer extension in Exchange or Outlook.

#### To transfer mail messages

- 1 Connect your Velo 1 to your desktop computer, and start H/PC Explorer.
- 2 In Microsoft Exchange or Outlook on your desktop computer, click **H/PC Inbox Transfer** on the **Tools** menu.
- 3 Under **Transfer messages from your H/PC**, select the messages you want to save.
- 4 Click **OK**.
- 5 Select a folder to transfer messages to, or click **New Folder** create a new folder.

**Note:** The original dates and times of the messages you transfer will be changed to the date and time the at which messages were transferred.

### 1b: Remove the main battery (or batteries) and the backup battery from your Velo 1.

**Important:** You must remove **all** batteries before you install the Windows CE 2.0 ROM Miniature Card. If you don't, the upgrade will not work properly.

### 1c: Install the Windows CE 2.0 ROM Miniature Card.

**Warning:** When you install the Windows CE 2.0 ROM Miniature Card, all information on your Velo 1 will be erased. Before you install the ROM Miniature Card, back up all information by following the procedures described in the previous section, "Save your Velo 1 data."

**To install the Windows CE 2.0 ROM Miniature Card**

- 1** Back up all files on your Velo 1 as described above.
- 2** Turn off your Velo 1.
- 3** On the bottom of your Velo 1, slide back the latch to release the door to the Flash/ROM Miniature Card slot and remove the door to the slot and the dummy card or Flash Card.

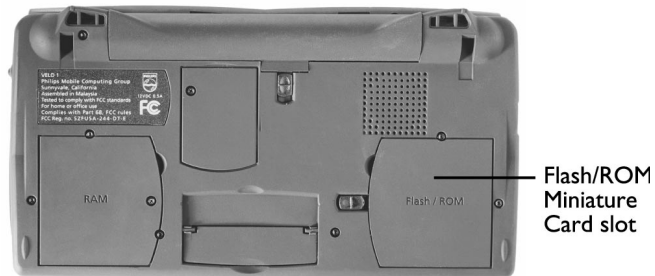

- 4** Insert the ROM Miniature Card into the slot, and push the card down until it snaps into place.

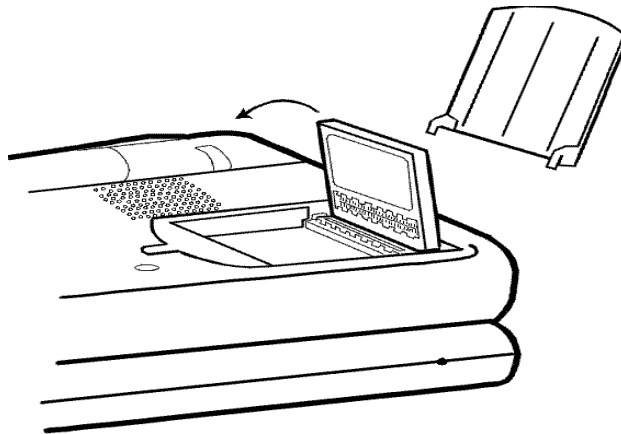

- 5** Replace the door.

**Note:** Do not remove the Windows CE 2.0 ROM Miniature Card from the Flash/ROM Miniature Card slot. After you install the ROM Miniature Card, you will be unable to use the Flash/ROM Miniature Card slot for other cards, such as flash memory upgrades or programs that come on Miniature Cards.

## 1d: Install more RAM in your Velo 1.

If you do not have 12 MB of RAM installed on your Velo 1 you will need to install enough RAM to bring your device up to 12 MB in order to proceed with the upgrade.

- 1 Take your Velo 1 out of the Velo Dock.
- 2 Remove the screw from the DRAM Miniature Card slot and remove the slot door.
- 3 If there is a card (or a plastic dummy card) already in the slot, remove it.
- 4 Insert the 8 MB DRAM Miniature Card in the slot by pushing down the card until it snaps into position.
- 5 Replace the door and the screw.

## 1e: Follow the steps below and reinsert the main battery (or batteries) and the backup battery.

- 1 Plug the supplied AC adapter into your Velo 1 and a wall outlet.
- 2 Press the Power button to turn on the Velo 1.
- 3 The Welcome Wizard appears; ignore it for now.
- 4 **Unplug the AC adapter from the Velo 1.**
- 5 Insert the main battery and the backup battery. (See the figures on page 14.)
- 6 **Plug the AC adapter into the Velo 1.**
- 7 Press the Power button to turn on the Velo 1.
- 8 Tap  to close the Expansion Memory Detected dialog window.

After you reinsert the batteries, go to “Step 2: Install Windows CE Services 2.0 on Your Desktop Computer” on page 15.

**Step 1: If you purchased the Velo 1 with 12 MB of DRAM and the Microsoft Windows CE 2.0 Upgrade Card already installed, start here:**

- 1** Plug the supplied AC adapter into your Velo 1 and a wall outlet.
- 2** Press the Power button to turn on the Velo 1.
- 3** The Setup Wizard appears; ignore it for now.
- 4 Unplug the AC adapter from the Velo 1.**
- 5** Insert the main battery and activate the backup battery. (See the figures on the next page.)
  - a** Slide the main battery door lock.
  - b** Open and detach the battery door.
  - c** Pull out the yellow plastic tab and discard it. (This step activates the backup battery.)
  - d** Insert the NiMH rechargeable battery pack.
  - e** Replace the battery door.
- 6 Plug the AC adapter into the Velo 1.**
- 7** Press the Power button to turn on the Velo 1.
- 8** Tap  to close the Expansion Memory Detected dialog window.

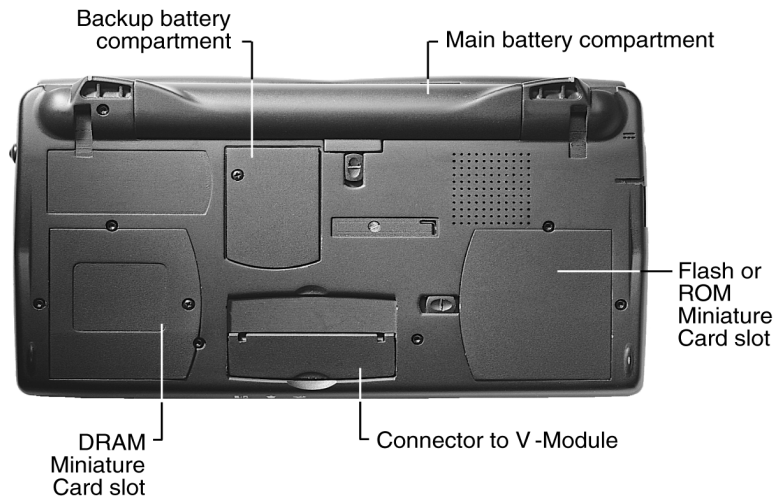

**Bottom of Velo 1**

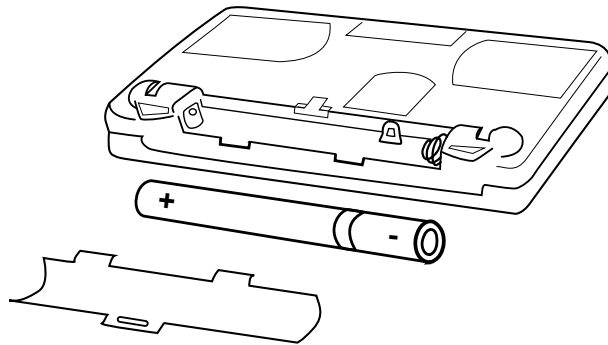

**Bottom view showing rechargeable battery pack insertion**

## Step 2: Install Windows CE Services 2.0 On Your Desktop Computer

### System requirements

The minimum PC requirements for running Windows CE Services 2.0 are as follows:

- ▶ Microsoft Windows NT® Workstation 4.0 or Windows 95
- ▶ Desktop computer with a 486/33DX or higher processor (Pentium P90 recommended)
- ▶ 12 MB of memory for Windows NT Workstation 4.0
- ▶ 8 MB of memory (12 MB recommended) for Windows 95
- ▶ Hard disk drive with 10 to 50 MB of available hard-disk space (actual requirements will vary, based on selection of features and current system configuration)
- ▶ Available 9- or 25-pin communications port (25-pin port requires adapter)
- ▶ CD-ROM drive
- ▶ VGA or higher-resolution graphics card (Super VGA 256-color recommended)
- ▶ Keyboard
- ▶ Microsoft Mouse or compatible pointing device

In addition, the following optional system components will allow you to use certain features of Windows CE Services:

- ▶ Audio card and speakers for sound
- ▶ Microsoft Office 97 or Microsoft Office 95
- ▶ Serial or built-in infrared adapter for synchronization
- ▶ Modem for remote synchronization
- ▶ Ethernet LAN connection for remote synchronization

In addition to Windows CE Services 2.0, the *Microsoft Windows CE* compact disc contains Microsoft Schedule+, updates to the Windows Messaging System (Microsoft Exchange), and Windows 95 Dial-Up Networking and some optional items. The installation program will check for and install these components as necessary to ensure that you can set up and run Windows CE Services 2.0, as well as applications including Pocket PowerPoint® and Pocket Streets.

## Installing Windows CE Services 2.0

The Windows CE Services 2.0 installation program includes several steps. The steps you follow depend on your operating system (Windows 95 or NT) and system configuration. When you run Setup, it tests for installed components and prompts you to install only those components you need. To ensure that you install all the necessary components, simply click each button in order on the Setup screen. You may be instructed to restart your computer several times during the installation procedure.

To install Windows CE services on your desktop computer, follow these steps:

- 1** Insert the *Microsoft Windows CE* compact disc in a CD-ROM drive on your desktop computer.  
Setup begins automatically. If Setup does not begin automatically, click **Run** on the **Start** menu, then type *d:setup* (where *d*: is the letter of the drive containing the *Microsoft Windows CE* CD) and press **Enter**.
- 2** Follow the instructions on your screen to complete installation.
- 3** When the “Get Connected” dialog box appears, click **Cancel**. Proceed to Step 3 on page 17.



## Step 3: Prepare Your Velo 1 and Your Desktop Computer for Velo 1 Application Installation



Before you install Velo 1 applications, you must set the PC connection on your Velo 1. Instructions for setting the connection are below.

If you are an experienced user, you may want to set up your Velo 1 and your computer to make the installation procedure go much more quickly. Making these changes requires many more steps, but greatly speeds up the installation process. If you choose to make these changes, skip the instructions below (“To set the PC connection on your Velo 1”) and follow the instructions on the next page, “To increase the speed of data transfer between your Velo 1 and desktop computer.”







### To set the PC Connection on your Velo 1

- 1 Make sure your Velo 1 is turned on.
- 2 Tap **Start** in the lower left-hand corner, tap **Settings**, then tap **Control Panel**.
- 3 Double-tap **Communications**.
- 4 Tap the **PC Connection** tab.
- 5 Tap the **Change** button.
- 6 Under **Connect to desktop computer using**, select **Desktop @ 19200**.

**Important:** Even though **Desktop @ 19200** is the default setting, you still need to select it to make it active.

- 7 Tap  to close the PC Connection dialog box.
- 8 Tap  to save the Communications settings.
- 9 Go to “Step 4: Install Velo Applications From the *Velo 1 Upgrade CD*” on page 20.

**To increase the speed of data transfer between your Velo 1 and desktop computer**

- 1** Disconnect the Velo 1 from the desktop computer.
- 2** On the Velo 1, tap **Start**, tap **Programs**, tap **Communication**, then tap **Remote Networking**.
- 3** Double-tap **Make New Connection**.
- 4** Under **Type a name for the connection**, type a name (such as "Fastest"), then tap **Next**.
- 5** Tap **Configure**, and then in the **Baud Rate** list, select the desired rate (typically 115,200 baud is the fastest), then tap .
- 6** Tap **Finish**. Tap  to close the window.
- 7** Tap the **Start** menu, tap **Settings**, then tap **Control Panel**.
- 8** Double-tap **Communications**.
- 9** Select the **PC Connection** tab, then tap **Change**.
- 10** Under **Connect to desktop computer using**, select the connection you created above.
- 11** Tap , then tap  again to close the Communications control panel. Tap  to close the window.
- 12** Reset your Velo 1 (tap **Start**, tap **Run**, type *reset*, then tap ). In the Reset Velo 1 dialog box, tap **Yes**.
- 13** On your desktop computer, open the **Mobile Devices** window. In the **File** menu, click **Communications**, clear **Enable mobile device connection** and click **Apply**.
- 14** If you are using Windows 95, go to step 15. If you are using Windows NT, go to step 16 on the next page.

- 15** If you are using Windows 95:
  - a** On your desktop computer, click **Start**, point to **Settings**, click **Control Panel**, then double-click the **System** icon.
  - b** Click the **Device Manager** tab, double-click **Modem**, then select the port to which your Velo 1 is connected.
  - c** Click **Properties**, click the **Modem** tab, and then under **Maximum speed** select the same rate you specified on your Velo 1. Tap  to close the window.
  - d** Click **OK**, then click **OK** again to close the System Properties dialog box. Tap  to close the window.
  - e** Go to step 17 below.
- 16** If you are using Windows NT:
  - a** On your desktop computer, click **Start**, point to **Settings**, then click **Control Panel**.
  - b** Double-click the **Modems** icon.
  - c** Select **Dial-Up Networking Serial Cable between 2 PCs**, then click **Properties**.
  - d** Set the **Maximum speed** to the same rate you specified on your Velo 1, click **OK**, then click **Close**.
  - e** Go to step 17 below.
- 17** In the **Mobile Devices** window, open the **File** menu, click **Communications**, select **Enable mobile device connection**, and click **Apply**.
- 18** Close all desktop programs and restart your computer.

## Step 4: Install Velo 1 Applications From the *Velo 1 Upgrade CD*

The *Philips Velo 1 Upgrade* compact disc includes programs and components of the Velo 1 applications and operating system. You must install these components to ensure that all features of your Velo 1 will function as intended. To install these programs from the CD, follow these steps:

- 1 Connect the Velo Dock's cable to the desktop computer's serial port.
- 2 Plug the AC power adapter into the DC jack on your Velo Dock.
- 3 Place your Velo 1 in the Velo Dock and firmly slide the H/PC until it snaps into place and the green light comes on. Open the lid of the Velo 1 and make sure it is on.

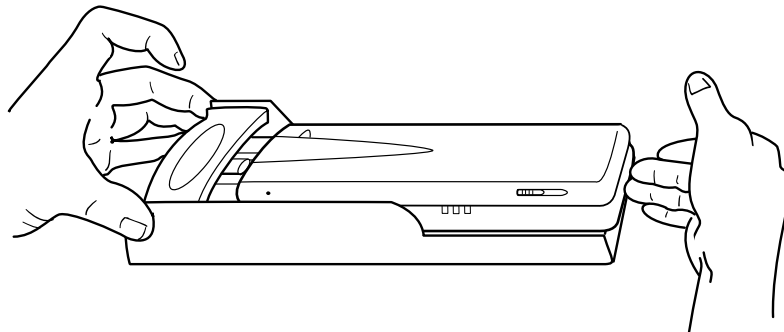

- 4 In **My Computer** (on your desktop computer), browse to the **Mobile Devices** folder and double-click the **Velo 1** icon to start Windows CE Services 2.0.

**Note:** The first time you connect your Velo 1, Windows CE Services 2.0 may prompt you to select a communications port. Select the port to which your Velo Dock or serial cable is connected, and make sure the port speed is set to the speed you set your Velo 1 to in "Step 3: Prepare Your Velo 1 and Your Desktop Computer for Velo 1 Application Installation."

- 5 The first time you connect your Velo 1, you will be prompted to establish a new partnership. Accept the the default choices until you see the screen for ActiveSync. Uncheck (disable) the box that says “Enable synchronization.” Click **Next**. Click **Finish**. You know you are “partnered” when your Velo 1 icon appears in the **Mobile Devices** folder window. If the icon does not appear, select Refresh from the View Menu.
- 6 Insert the *Philips Velo 1 Upgrade* compact disc into the CD-ROM drive on your desktop computer.  
The installation program starts automatically. If the installation program does not start automatically, click **Run** on the **Start** menu, and then type *d:setup* (where *d:* is the letter of the drive containing the *Philips Velo 1 Upgrade* compact disc) and press **Enter**.

**Note:** The installation program uses your desktop computer’s Internet browser. If you do not have a browser installed on your desktop computer, install Microsoft Internet Explorer from the *Philips Velo 1 Upgrade* compact disc.

- 7 In the installer window, click **Install Velo 1 Upgrade**.
- 8 Read the **Welcome** screen, then click **Next** to proceed with installation.
- 9 Follow the instructions on screen to complete software installation.

**Caution:** While the Philips Velo applications are being installed, do not reset your Velo 1.

**Note:** The installer will ask if your Velo 1 has at least 12 MB of RAM. If it doesn’t, when the installer tells you to install additional RAM, follow the instructions on page 12.

- 10 When the installer asks if you want to install “PMGC non-removeable items using the default application install directory,” click **Yes**.

**Note:** The installation of the applications can take a while. If you leave your system, be sure to keep checking the status. If you leave it too long the installation will fail (the program will time-out) and you will have to start over. When setup is complete, you'll see a message on your desktop computer.

- 11** When you see a message on your Velo 1 asking "Would you like to replace the existing file?" tap **Yes to all**. This step installs the latest updates on your Velo 1.
- 12** When you see the "Reset Velo 1?" message on your Velo 1, tap **Yes**.
- 13** Navigate to the Mobile Devices Window on your desktop computer and open it. Select your Velo 1. Open the **Tools menu**, and choose **ActiveSync Options**. Check (enable) the box that says "Enable synchronization" and click .
- 14** If you are upgrading your Velo 1 with the upgrade kit, go to Step 5 on the next page to retrieve your data.

If you purchased your Velo 1 with 12 MB of DRAM and the Microsoft Windows CE 2.0 Upgrade Card already installed, go to the section "Using your Velo 1" on page 25.

## Step 5: Retrieve Your Data

You must complete this step only if you purchased the Microsoft Windows CE 2.0 Upgrade Kit and you saved Velo 1 data as instructed in Step 1.

After you've established the partnership between your Velo 1 and desktop computer, you can restore the files and PIM data that you backed up before upgrading.

**Files** — You can now restore individual files by moving files and folders from your desktop computer to your Velo 1.

### To restore individual files

- 1 Connect your Velo 1 to your desktop computer.
- 2 In **My Computer**, browse to the **Mobile Devices** folder and double-click the **Velo 1** icon.
- 3 Browse to the folder you created during the backup procedure, and drag individual files to the Mobile Devices window, or use the **Cut** and **Paste** commands to move the files from the backup folder to your Velo 1.

**Caution:** Do not use the Windows CE Services Restore function to restore data after installing the Velo 1 applications and other components from the *Philips Velo 1 Upgrade* compact disc..

**Programs** — You will need to reinstall any programs you've added to your Velo 1 from the original source. In some cases, existing programs may not be compatible with Windows CE 2.0. Check with the program's manufacturer to find out if you need a new version.

**Settings** — Program and device settings, such as TCP/IP and network settings for remote connections, settings for Inbox services, alarms and reminders, desktop patterns, and sound schemes must be restored manually. You will need to start each program or open the control panel to restore any options you had set previously.

**PIM data** — Calendar, Contacts, and Tasks data can be restored to the new Pocket Outlook™ databases by synchronizing your Velo 1 with Microsoft Schedule+ or Microsoft Outlook on your desktop computer. (If you chose to have the New Partnership Wizard synchronize Calendar, Contacts, and Tasks data when you first connected your upgraded Velo 1 to your desktop computer, your Pocket Outlook data has already been restored, and you can skip this section.)

### To synchronize Pocket Outlook

- 1 Connect your Velo 1 to your desktop computer.  
If you have set Windows CE Services 2.0 to synchronize on connecting, synchronization will take place automatically.
- 2 If you have not set Windows CE Services 2.0 to synchronize on connecting, on your desktop computer, open the **Mobile Devices** folder (in My Computer) and double-click the Velo 1 icon.
- 3 In the **Mobile Devices** window, click **Synchronize Now** on the **Tools** menu.

**Mail messages** — If you have Microsoft Exchange or Outlook on your desktop computer, you can transfer messages to your Velo 1, using the Inbox Transfer extension in Exchange or Outlook.

### To transfer mail messages

- 1 Connect your Velo 1 to your desktop computer.
- 2 In Microsoft Exchange or Outlook on your desktop computer, select the messages you want to transfer.
- 3 On the **Tools** menu, click **H/PC Inbox Transfer**.
- 4 Under **Transfer messages to your H/PC**, select the folder you want the messages saved in.
- 5 Click **OK**.

**Note:** The original dates and times of the messages you transfer will be changed to the date and time at which the messages were transferred.



## Using Your Velo 1

The Setup Wizard leads you through a few simple setup procedures, such as calibrating the touch screen; setting the date, time, and time zone; and storing personal information such as your name, address and telephone number. To start the Setup Wizard, tap **Start**, select **Run**, type in *welcome*, and press **Enter**.

You can change these settings at any time. For more information, see Windows CE Help. To access Windows CE Help, tap **Help** on the **Start** menu or tap **?** on the title bar. When you open Help, you'll see topics for the application or system component you are using. To see a list of all the Help contents, tap **Other Help**.

## What's on Your Velo 1?

Your Velo 1 uses Microsoft Windows CE, which is based on the Microsoft Windows 95 operating system. It includes familiar components such as the **Start** button and **Start** menu, taskbar, desktop, browser, menu bar and toolbar, Control Panel, and shortcuts.

Your Velo 1 also includes programs for your Velo 1 that help you manage your schedule, retrieve and store information, communicate with others via e-mail, and explore the World Wide Web. These programs work alone and in conjunction with your desktop computer. You can synchronize Schedule+ information and transfer files between your handheld PC (H/PC) and your desktop computer to ensure you're always working with current information.

### Windows CE 2.0

Some of Windows CE 2.0's features are summarized below. For a complete description of the features and detailed instructions, refer to Windows CE Services Help. You can also download a Guided Tour from Microsoft's Web site: [www.microsoft.com/WindowsCE](http://www.microsoft.com/WindowsCE).

- ▶ **Address bar** — The Windows CE Address Bar displays the full path of the folder you're viewing in Explorer view and lets you quickly select recent folders from a drop-down list.
- ▶ **Calculator** — Perform calculations using on-screen buttons and keep track of calculations with an on-screen "paper tape." In addition, you can copy data and paste it into documents and spreadsheets.
- ▶ **Graphic formats** — Windows CE 2.0 supports .bmp files, the same bitmap file format used by Windows 95. Bitmap files can be transferred to your Velo 1 without conversion.
- ▶ **Help** — The Windows CE Help system includes detailed procedures and instructions for all major programs.
- ▶ **Inbox** — Send and receive Internet mail, and send faxes. If you have MicroBurst Virtual Courier™ Personal Edition on your desktop computer or company file server, you can also access cc:Mail™ and Microsoft Mail accounts. And if you're running Microsoft Exchange on your desktop computer, you can transfer messages between your H/PC and desktop computer.
- ▶ **Information Manager for Windows CE** — Track contacts, manage your schedule, and organize tasks. In addition, you can set reminders to ensure you never miss an important appointment.

- ▶ **Office** — The Pocket Office group includes Pocket Word and Pocket Excel, as well as an H/PC version of the popular presentation program Microsoft PowerPoint.
  - **Pocket Word** — Take notes, compose memos, and review reports anytime, anywhere. You can create and edit files in Pocket Word, and then transfer them to Microsoft Word for printing. Includes the Zoom feature, which lets you control the size of the document display, and a spelling checker to help catch any mistakes.
  - **Pocket Excel** — Calculate expenses, create reports, or manage data. In addition, you can track an investment return or keep an up-to-date mileage log while you're on the road. Includes Split Pane and Freeze Pane views as well as the Zoom feature so that you can display specific areas of your spreadsheets and control exactly what you see on the screen.
  - **Pocket PowerPoint** — Lets you use your Velo 1 to view presentations created on your desktop computer. You can display and edit presentations on the Velo 1 screen, or connect to a VGA monitor using an optional V-Module and a VGA PC Card.
- ▶ **Pocket Internet Explorer version** — View the wide range of information available on the Internet.
- ▶ **Pocket Outlook** — Pocket Outlook integrates the Calendar, Contacts, and Tasks applications with each other and with the Inbox program on your Velo 1. The components work together, so when you schedule a meeting with Calendar, you can automatically send e-mail reminders to all attendees, using Inbox and Contacts. You can also use the **Go** menu to quickly switch between components. And you can synchronize your Calendar and To-Do lists with Outlook or Schedule+ on your desktop computer.
- ▶ **Start menu** — The Windows CE Start menu organizes your programs into groups that make it faster to find the programs you need. The **Start** menu also features cascading menus, much like Windows 95.

- ▶ **Taskbar controls** — You can hide the taskbar to increase the screen area and view more of your documents or calendar. To set taskbar options, point to **Settings** on the **Start** menu, and tap **Taskbar**.
- ▶ **World Clock** — Keep track of the current date and time whether you're at home or away. You can set the clock to keep time for your home city and for a place you're visiting. World Clock stores information on time zones, airports, dialing codes, and distances, and even calculates sunrise and sunset for any city in the world.

#### Other software

Your Velo 1 also includes several other programs. All preinstalled programs are accessible from the **Start** menu, in the program groups described below:

#### **Velo 1 Applications**

- ▶ **bFAX Pro and bView** — These two full-featured programs from bSquare™ Development enable you to fax documents from your Velo 1 and to view faxes you receive from others. Use bFAX Pro for sending and receiving faxes and bView for previewing and adjusting the appearance of documents before they are faxed. You can also use bFAX Pro to send documents created in other programs on your Velo 1, such as Pocket Word (.pwd) files, H/PC bitmap (.2bp) files, received fax (.tif) files, and ASCII text (.txt) files. You can customize bFAX Pro by setting options for your cover page and page layout.
- ▶ **Characters** — Use the Characters program to enter characters or symbols and characters not available on the keyboard. Select a font from the drop-down list to display the complete character set for that font, then select and copy characters directly into other programs such as Pocket Word documents or e-mail messages.
- ▶ **Reset** — The Reset program (*reset.exe*) provides a reliable method for resetting your Velo 1, while preserving your data after you restore data from your desktop computer or when the operating system stops responding to your commands or stylus taps. There are several methods for resetting, depending on the severity of the problem, but you should try the Reset program first.

- ▶ **AllPen® Mobile Forms Database** — This program helps you organize information on your Velo 1 and share that information with your desktop computer. AllPen Mobile Forms Database lets you create, modify, and customize a database. After you have entered information into a personal database, you can update, sort, search, and manage your database with your Velo 1. You can view stored records, one record at a time or in a List view that shows all the records in the database. You can sort the information in your database or list all records that contain some piece of text in one of the fields. The information in the database is always saved in the Database folder on your Velo 1.
- ▶ **Unit Conversion** — Use the Unit Conversion program to convert between English and metric units for distance, volume, weight, and temperature or to convert currency between many international monetary units. When converting currency, you can use the approximate exchange rates provided, or enter a more current exchange rate.
- ▶ **Voice Memo** — Record and manage spoken memos and other sounds, without even opening your Velo 1. The button on the lid provides convenient one-touch recording anywhere, whether you are walking down the street or sitting on the train. After you have recorded a voice memo, you can play it back, file it, or delete voice memos you no longer need. Use the Audio Levels control panel to set input and output levels for the Voice Memo program and to change settings that affect the quality and size of the voice memos you record.

### Communication

- ▶ **ActiveSync** — ActiveSync enables you to connect to one or more remote computers and synchronize your calendar, tasks, contacts, and mail messages between Pocket Outlook on your Velo 1 and Microsoft Outlook or Schedule+ on the remote computer. You can also synchronize files in the Synchronize Files folder on your Velo 1 with files in the My Documents or Personal folder on your desktop computer.
- ▶ **PC Link** — The PC Link program manages the connection between your Velo 1 and desktop computer. Use PC Link to connect or disconnect or to check the status of the current connection.

## Tips for Using Your Velo 1

- Press the Power button to turn your H/PC on and off. If you go several minutes without working on your Velo 1, it will preserve your work and suspend itself, shutting off automatically. Just press the Power button to start working right where you left off.
- You should use the supplied stylus to touch the screen. There's no harm in using your fingertip, but many features require the stylus for finer pointing.

**Warning:** Don't use sharp implements, such as keys or pens, to touch the screen. These objects can damage the screen.

- The Velo 1 includes a built-in modem for connecting to a telephone line. You can use the modem to explore the Internet, send and receive e-mail, send faxes, and connect to other services. Simply plug a standard telephone line into the RJ-11 jack to the left of the screen (see the figure on page 37).

**Note:** The built-in modem is designed for use only in the U.S. To use the built-in modem on your Velo 1, you must select **Internal modem on COM 4** when creating a new dial-up connection.



**Velo 1 with lid open**

### Indicator lights

- The green recharging indicator light turns on if your rechargeable battery pack is being recharged by your Velo Dock or an AC power adapter. The green light turns off when charging is complete.
- The red serial connection light blinks when your Velo 1 is connected to a desktop computer with Windows CE 2.0 Services (or other serial connection) and a software connection has been established.
- The yellow alarm indicator light blinks to indicate an alarm you have set. This light stops blinking when you tap  to close the alarm's dialog box or double-tap the alarm icon in the status area of the taskbar.

### **Battery tips**

The Velo 1 has two kinds of batteries:

- Main batteries power your H/PC during normal mobile use.
- The backup battery provides enough power to keep your data safe if no other power source (main batteries or external power) is available. The backup battery was installed at the factory, but it must be activated before it will protect your data.

You can run your Velo 1 virtually anywhere on battery power. If you're close to an AC power outlet, you can connect to the power adapter that is supplied with your Velo 1.

### **Protecting your data during low power**

If you are using AA batteries, do not remove these batteries from your Velo 1 until you are ready to replace them with fresh batteries. Even when AA batteries are too low to turn on the H/PC, they may still have enough power to protect your saved data for more than a week.

If you remove the main batteries, the backup battery will maintain your data for one or two days; however, to ensure maximum protection, you should leave the main batteries installed and replace them with a fresh pair as soon as possible.

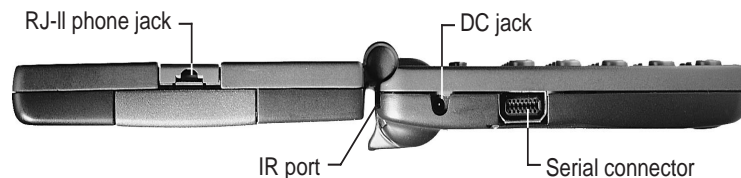

**Side view of Velo 1 (left side)**



### To replace the backup battery

When you see a message that you need to replace the backup battery, follow these steps:

- 1 Make sure the main batteries are working, or plug the Velo 1 into a wall outlet with the supplied AC power adapter.
- 2 Remove the screw from the backup battery door, then remove the door and the old battery.
- 3 Insert a CR2032 (or equivalent) lithium coin cell backup battery.

The side marked with a + (plus sign) faces up.

- 4 Replace the backup battery door and the screw.

### To connect to external power

**Warning:** Use only Philips power adapters designed specifically for use with the Velo 1; otherwise you may damage your H/PC.

- 1 Plug the power adapter into an AC power outlet.
- 2 Plug the AC power adapter into the DC jack on either your Velo 1 or Velo Dock.

If the rechargeable battery pack is installed, the batteries will be recharged while your H/PC is connected to AC power.

**Note:** If the rechargeable battery pack is installed, the first time you connect your Velo 1 to AC power you should fully charge the battery pack before you disconnect the AC power adapter. Charging takes about two and a half hours. While the battery pack is charging, the green recharging indicator light is on. The light turns off when charging is complete.

### Resetting your Velo 1

Occasionally, you will need to reset your Velo 1, for example, after you restore data from your desktop computer or when the operating system stops responding to your commands or stylus taps. There are several methods for resetting, depending on the severity of the problem. In most cases, you can reset your Velo 1 without losing any data; however, to ensure the safety of your information you should regularly back up your data to your desktop computer.

In general, the Reset program (*reset.exe*) is the most reliable method for resetting your H/PC while preserving your data. The Reset program is in the Velo Applications folder on your Velo 1.

#### **To reset your Velo 1 using the Reset program**

- 1** On the **Start** menu, tap **Run**.
- 2** In the run dialog box, type **reset**, and then tap **OK**.
- 3** In the Reset Velo 1 dialog box, tap **Yes**.

**Important:** Only when the Reset program fails to correct a problem should you press the Reset button with the stylus. Pressing the Reset button once should retain the data stored on your Velo 1; however, pressing the Reset button multiple times will cause your Velo 1 to do a full restart, erasing all information.

In the most severe cases, when your Velo 1 doesn't respond to the Reset button or if you forget your password, you may need to perform a full restart by removing all power, including the main and backup batteries, from your Velo 1. Resetting in this way erases all files you've saved and all programs you've installed on your Velo 1. If you perform a full restart, you will have to reinstall the software on the *Philips Velo 1 Upgrade* CD.

## Frequently Asked Questions

The following information provides answers to questions that are frequently asked by users when setting up their H/PCs for the first time.

**Q:** How much total memory is available on my H/PC?

**A:** In the System control panel, tap the **General** tab to view system information, including the total installed DRAM memory (this does include DRAM Miniature Cards).









**Q:** How do I know how much free storage space I have on my H/PC?

**A:** In the System control panel, tap the **Memory** tab to view how much storage and program memory is in use. Move the slider to allocate more memory for either programs or storage.

**Q:** What does the  key do?

**A:** It performs the same function as the Windows key found on newer PC keyboards.

### Use this key combination    To perform this function

	Open <b>Start</b> menu
 +K	Open Keyboard control panel
 +I	Open Stylus control panel
 +C	Open Control Panel
 +E	Explore My Handheld PC
 +R	Display the <b>Run</b> dialog box
 +H	Open Windows CE Help
CTRL+  +A	Select All on desktop

**Q:** How do I minimize a document or application?

**A:** Tap the application button on the taskbar.

**Q:** How do I turn on CAPS LOCK?

**A:** Press both SHIFT keys at the same time. When CAPS LOCK is on,  appears in the toolbar.

**Q:** How can I check my battery power?

**A:** Double-tap the power icon in the control panel.

**Q:** How do I “right-click”?

**A:** Not all H/PC applications support the right-click. In the Windows CE Explorer, press and hold down the ALT key while you tap an item.

**Q:** Does  work the same as in Windows 95?

**A:** When the  button appears on the toolbar, tapping  will close a window without saving changes.

**Q:** How do I print documents on my H/PC?

**A:** You can print documents directly from your H/PC with the proper connection to a printer or from Windows CE Services on your desktop computer.

## Quick Start keys

The Velo 1 provides Quick Start keys, a fast way to use the keyboard to go to many of your favorite programs.

To use a QuickStart key to start a program, hold down the ALT key and press one of the number keys. The following table lists the Quick Start keys you can use:

### **Quick Start keys Program started**

ALT + 1	Pocket Word
ALT + 2	Pocket Excel
ALT + 3	Calendar
ALT + 4	Contacts
ALT + 5	Tasks
ALT + 6	Pocket Internet Explorer
ALT + 7	Inbox
ALT + 8	Database
ALT + 9	Calculator
ALT + 0	Voice Memo

You can use the Quick Start keys control panel to reprogram QuickStart keys to open any application.

## Cleaning and Maintaining Your Velo 1

Clean the casing of your Velo 1 with a damp cloth. For more persistent dirt such as grease or oils, use a solution of a mild detergent in water. Always wipe off your Velo 1 with a dry cloth after cleaning.

To clean the touch screen, use a damp cloth or a premoistened pad designed specifically for use on computer monitors.

## Using the built-in modem

The Velo 1 includes a built-in modem for connecting to a telephone line. You can use the modem to explore the Internet, send and receive e-mail, send faxes, and connect to other services.

### To connect to a telephone line

- 1 Lift the RJ-11 jack away from the case, and plug in a standard telephone line.
- 2 The RJ-11 jack is to the left of the screen, in the center.

**Note:** The built-in modem is designed for use only in the U.S.

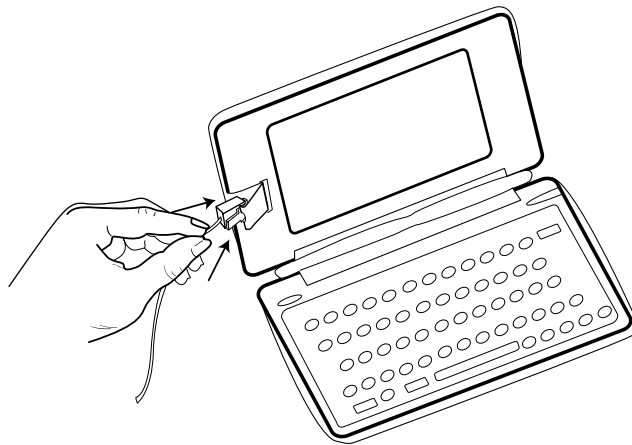

### RJ-11 phone line connection

**Note:** To use the built-in modem on your Velo 1, you must select **Internal modem on COM 4** when creating a new dial-up connection.

## Hardware Specifications

### Physical description Velo 1

Dimensions 6.75" (171 mm) by 3.75" (95 mm) by 1.25" (32 mm)

Weight 13.2 oz. (370 g) without batteries

### Expansion

Velo Dock Provides connection to desktop computer and external power supply.  
Begins synchronization if software is running on desktop computer.  
Recharges batteries with battery pack installed.

### Power

Main batteries Requires 2 AA alkaline or lithium batteries or 1 NiMH rechargeable battery pack

Backup battery Requires CR2032 lithium coin cell

DC jack 12V @ 500mA

### Processor and basic input/output

Keyboard 61-key QWERTY layout  
Quick Start keys to start applications

Display Backlit, nonglare, touchscreen display

Grayscale LCD (480x240 pixels, .24mm dot pitch, .23mm dot size) with contrast dial and on-demand backlighting

CPU 3.3V 32-bit MIPS R3910 RISC processor @ 36.864 MHz

### Other input/output

Serial port RS-232 serial port  
Supports data transfer rate up to 230 Kbps

Infrared transceiver Meets IrDA standard (Level 1)  
Data transfer rate up to 115Kbps

Indicator lights	Green light indicates charging of the rechargeable batteries  Red light indicates communication over the Serial connector  Yellow light indicates alarms or messages
Audio in	Omnidirectional microphone used in conjunction with Voice Memo application  Records up to 16 minutes per Mbyte using TrueSpeech™ 8.5 sound compression
Audio out	Speaker on the bottom can play standard .wav files with sample rates:  8 kHz, 8 or 16 bit mono  11 kHz, 8 or 16 bit mono  11.025 kHz, 8 or 16 bit mono  22 kHz, 8 or 16 bit mono  22.050 kHz, 8 or 16 bit mono

#### **Communication**

Modem	Built-in 19.2 Kbps V.32/bis/ter data/fax modem  Compatible with ITU-T standards.  Data modes:  V.32 ter (adaptive rate 4800 - 19200 bps)  V.32 bis (adaptive rate 4800 - 14400 bps)  V.32 (adaptive rate 4800 - 9600 bps)  V.23 (1200 bps downstream, 75 bps upstream)  V.22 bis (2400 bps)  V.22 (1200 bps)  V.21 (0 - 300 bps)
-------	--



Fax modes (group 3, class 1):

V.29 (7200 bps, 9600 bps)

V.27 ter (2400 bps, 4800 bps)

Data link layers:

Async and HDLC framers

V.42 LAPM (error correction), not including MNP

Telephone line Low-profile RJ-11 jack connector

### Expansion

Velo Dock Provides connection to desktop computer and external power supply.

Begins synchronization if software is running on desktop computer.

Recharges batteries with battery pack installed.

Miniature Card slots Two industry-standard expansion slots for DRAM, Flash memory, or ROM upgrades.

Type II PC card V-Module (optional) Contains one PC card slot (Type II PCMCIA), power specification:  $V_{cc} = 5V @ 325mA$ ,  $V_{pp} = 5V$ .

## Regulatory Information

### Declaration of Conformity

This device complies with Part 15 of the FCC rules. Operations is subject to the following two conditions: (1) This device may not cause harmful interference, and (2) This device must accept any interference received, including interference that may cause undesired operation.

**Responsible Party Name** Philips Mobile Computing Group

**Telephone** 1-888-275-8356

**Product/Model** Velo 1

### FCC Warning Statement

This equipment has been tested and found to comply with the limits for a Class B digital device, pursuant to Part 15 of the FCC Rules. These limits are designed to provide reasonable protection against harmful interference in a residential installation. This equipment generates, uses and can radiate radio frequency energy. If not installed and used in accordance with the instructions, it can cause harmful interference to radio communications. However, there is no guarantee that interference will not occur in a particular installation. Determine if the equipment does cause interference to radio or television reception by turning the equipment off and on. The user is encouraged to try to correct the interference by one or more of the following measures:

- 1 Where it can be done safely, reorient or relocate the receiving antenna.**
- 2 Increase the separation between the equipment and receiver.**
- 3 Connect the equipment into an outlet on a circuit different from that to which the receiver is connected.**
- 4 Consult the dealer or an experienced radio/TV technician for help.**

Changes or modifications not expressly approved by the manufacturer could void the user's authority to operate the equipment. Shielded interface cables must be used when operating this device or the user's authority to operate this equipment could be voided.

## Telephone Consumer Protection Act of 1991

The Telephone Consumer Protection Act of 1991 makes it unlawful for any person to use a computer or other electronic device to send any message via a telephone facsimile machine unless such message clearly contains, in a margin at the top or bottom of each transmitted page or on the first page of the transmission, the date and time it is sent and an identification of the business, other entity, or individual sending the message and the telephone number of the sending machine or such business, other entity, or individual.

## FCC PART 68 Requirements

This equipment complies with Part 68 of the FCC rules. On the back of the computer is a label that contains, among other information, the FCC registration number and ringer equivalence number (REN) for this equipment. If requested, this information must be provided to the telephone company.

This equipment uses the following USOC jack: RJ11C

The REN is used to determine the quantity of devices which may be connected to the telephone line. Excessive REN's on the telephone line may result in the devices not ringing in response to an incoming call. In most, but not all areas, the sum of the REN's should not exceed five (5.0). To be certain of the number of devices that may be connected to the line, as determined by the total REN's contact the telephone company to determine the maximum REN for the calling area.

If this equipment causes harm to the telephone network, the telephone company will notify you in advance that temporary discontinuance of service may be required. If advance notice isn't practical, the telephone company will notify the customer as soon as possible. Also, you will be advised of your right to file a complaint with the FCC if you believe it is necessary.

The telephone company may make changes in its facilities, equipment, operations, or procedures that could affect the operation of the equipment. If this happens, the telephone company will provide advance notice in order for you to make the necessary modifications in order to maintain uninterrupted service.

If trouble is experienced with this equipment, please contact Philips Mobile Computing Group at 1-888-275-8356 for repair and (or) warranty information. If the trouble is causing harm to the telephone network, the telephone company may request you remove the equipment from the network until the problem is resolved.

This equipment cannot be used on telephone company-provided coin service. Connection to Party Line Service is subject to state tariffs.

This equipment is designed to be connected to the telephone network or premises wiring using a compatible modular jack which is FCC Part 68 compliant.

## Canadian IC CS-03 Requirements

**Notice:** The Industry Canada label identifies certified equipment. This certification means that the equipment meets certain telecommunications network protective, operational and safety requirements as prescribed in the appropriate Terminal Equipment Technical Requirements document(s). The Department does not guarantee the equipment will operate to the user's satisfaction.

Before installing this equipment, users should ensure that it is permissible to be connected to the facilities of the local telecommunications company. The equipment must also be installed using an acceptable method of connection. The customer should be aware that compliance with the above conditions may not prevent degradation of service in some situations.

Repairs to certified equipment should be coordinated by a representative designated by the supplier. Any repairs or alterations made by the user to this equipment, or equipment malfunctions, may give the telecommunications company cause to request the user to disconnect the equipment.

Users should ensure for their own protection that the electrical ground connections of the power utility, telephone lines and internal metallic water pipe system, if present, are connected together. This precaution may be particularly important in rural areas.

**Caution:** Users should not attempt to make such connections themselves, but should contact the appropriate electric inspection authority, or electrician, as appropriate.

#### Ringer Equivalence

The Ringer Equivalence Number (REN) of this device is 0.6B.

**Notice:** The **Ringer Equivalence Number (REN)** assigned to each terminal device provides an indication of the maximum number of terminals allowed to be connected to a telephone interface. The termination on an interface may consist of any combination of devices subject only to the requirement that the sum of the Ringer Equivalence Numbers of all the devices does not exceed 5. The equipment uses a CA11A jack.